

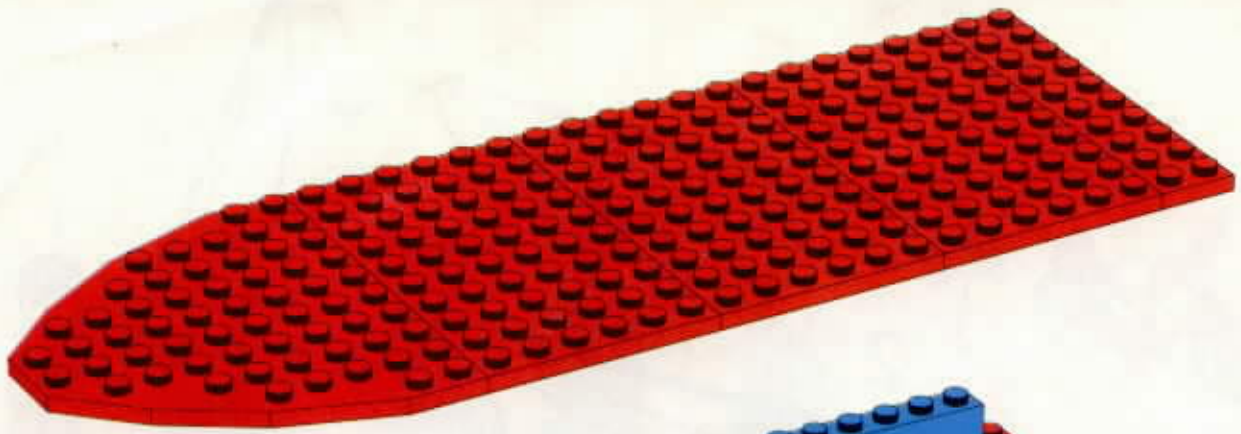

1

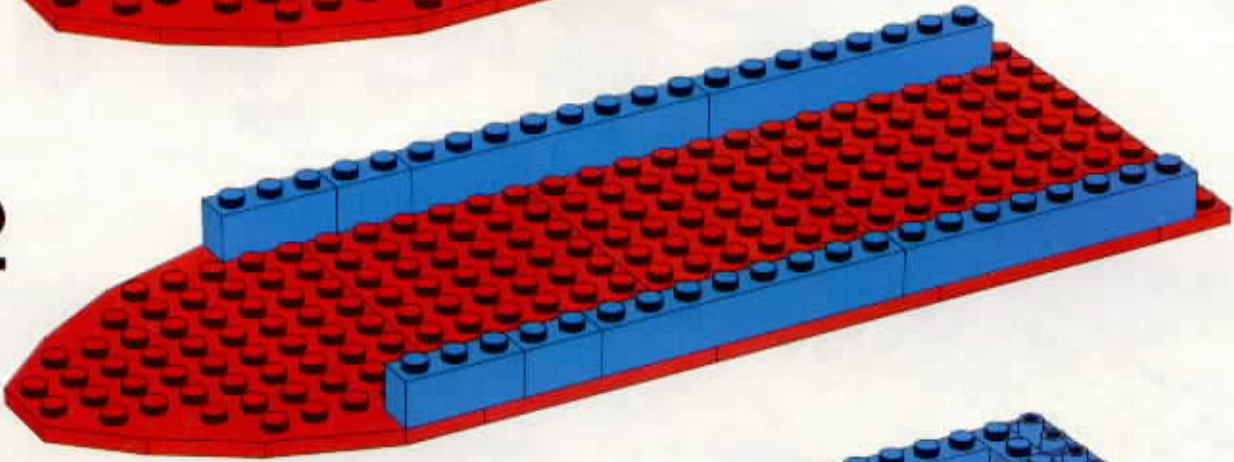

2



3

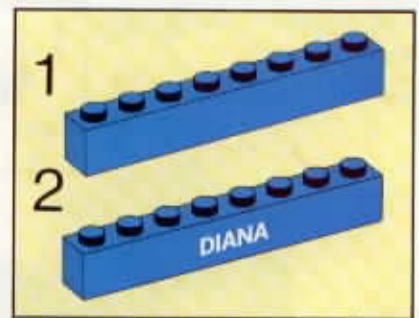
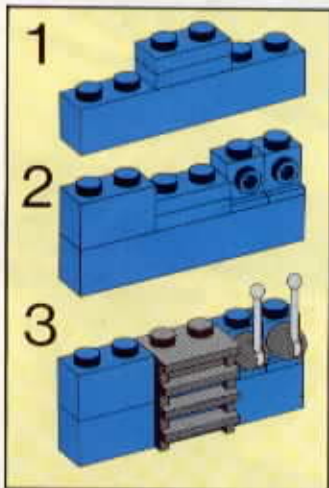
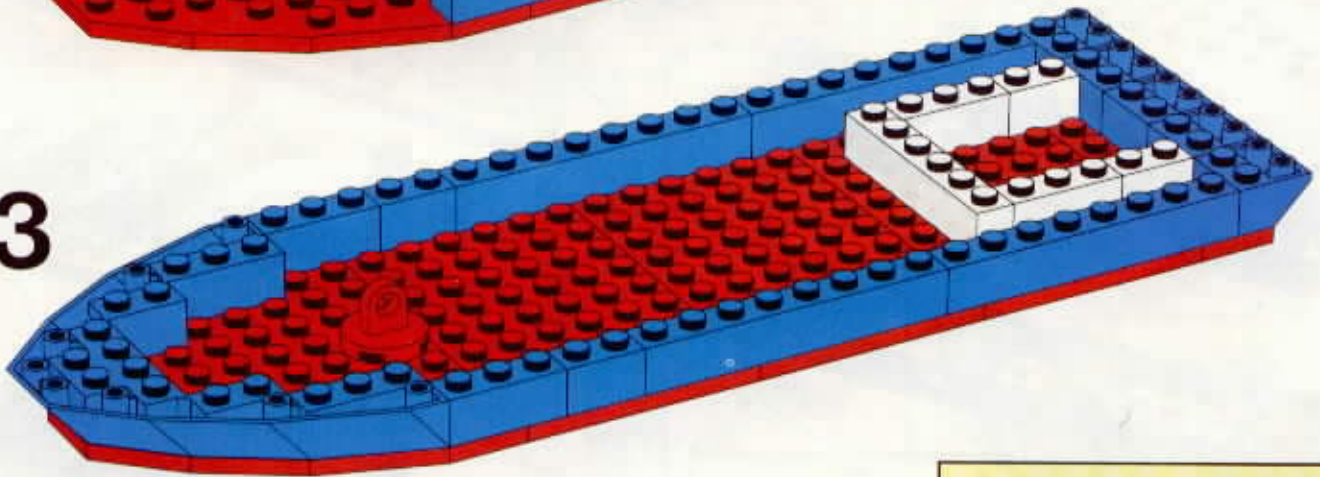

4

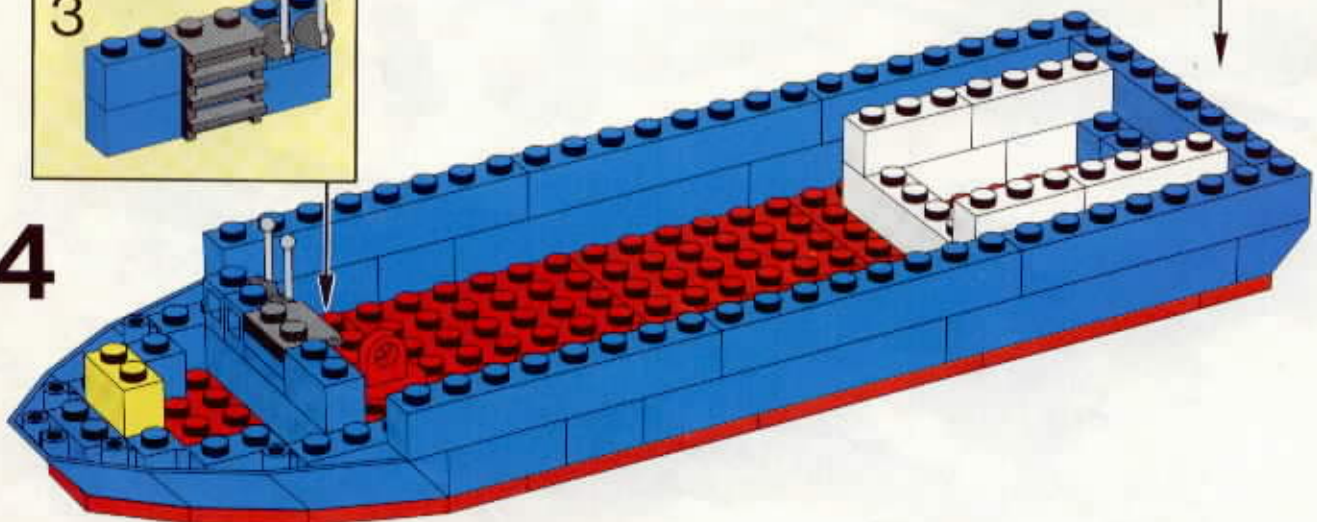



5

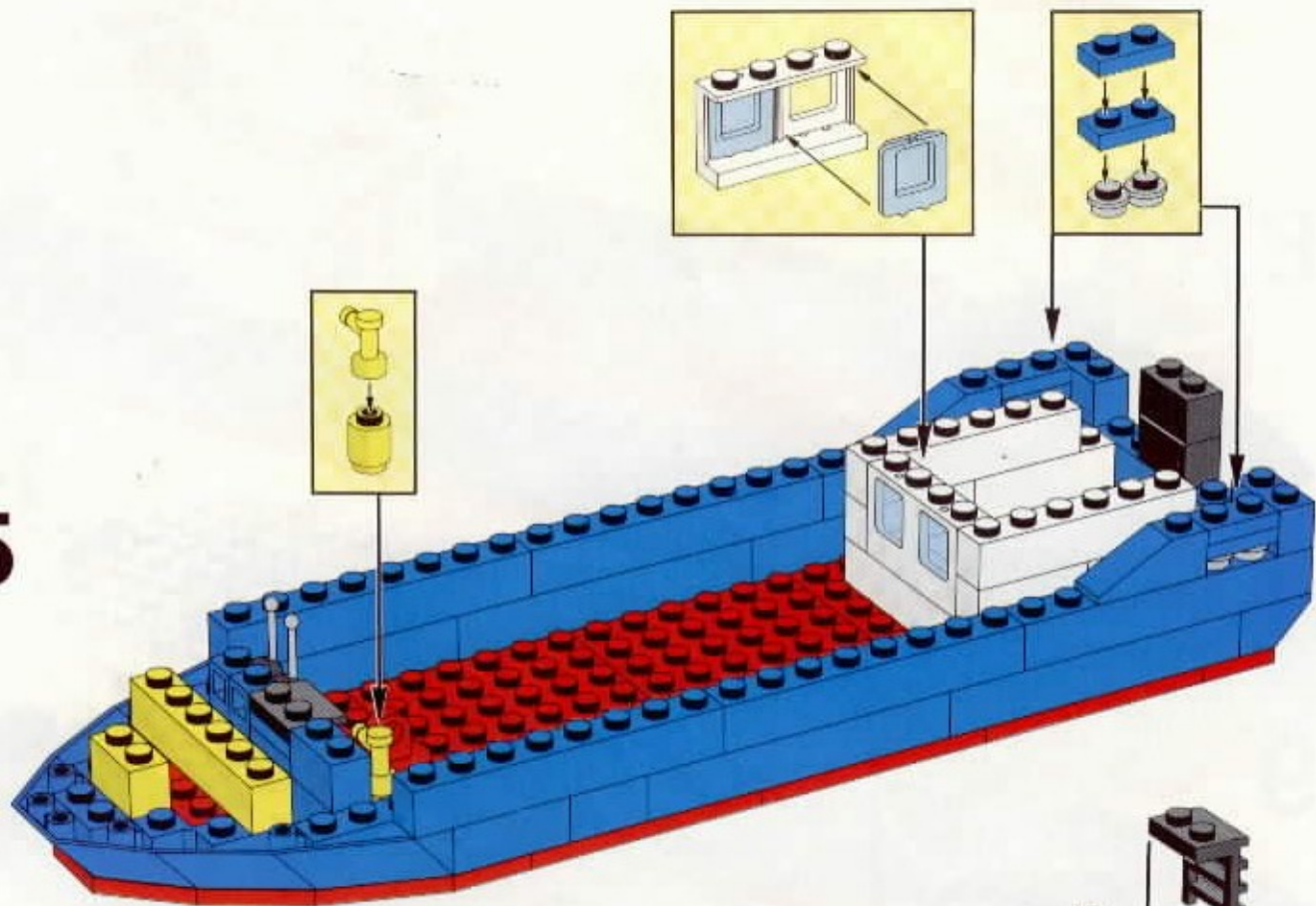

6

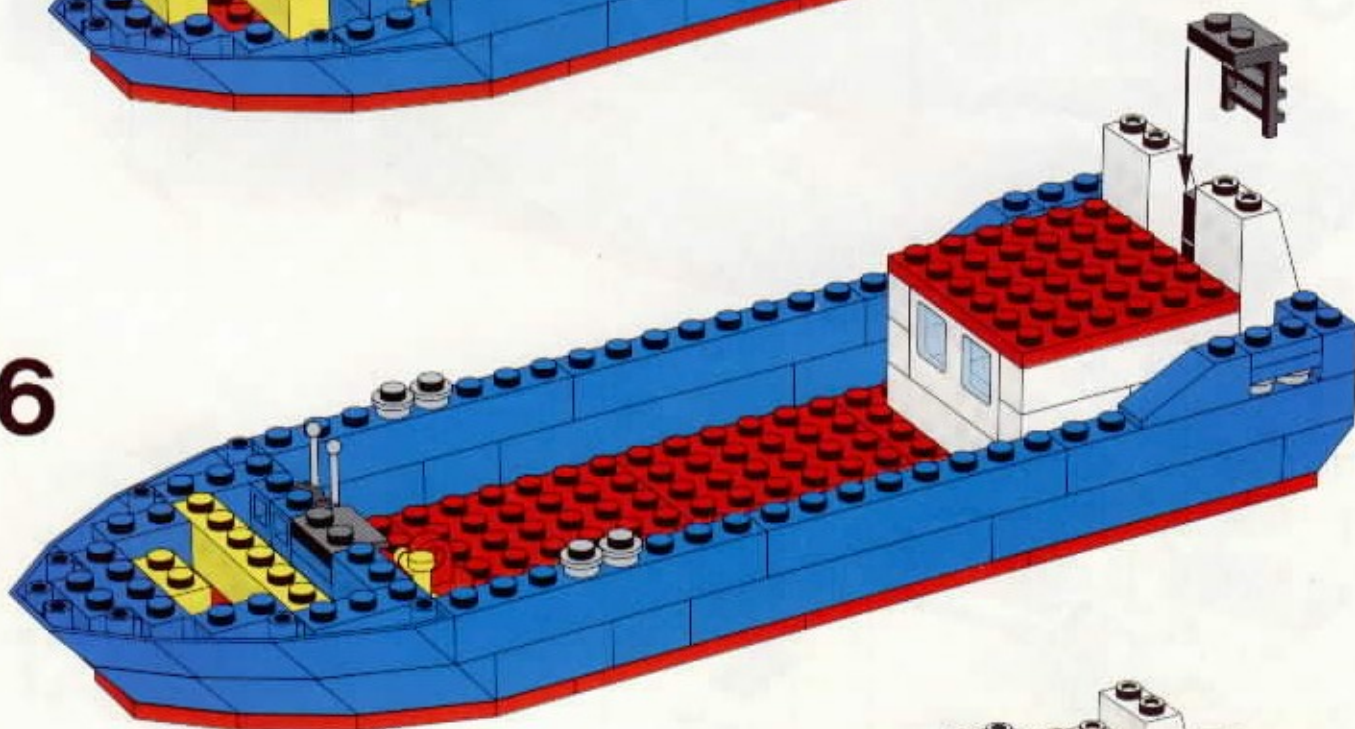

7

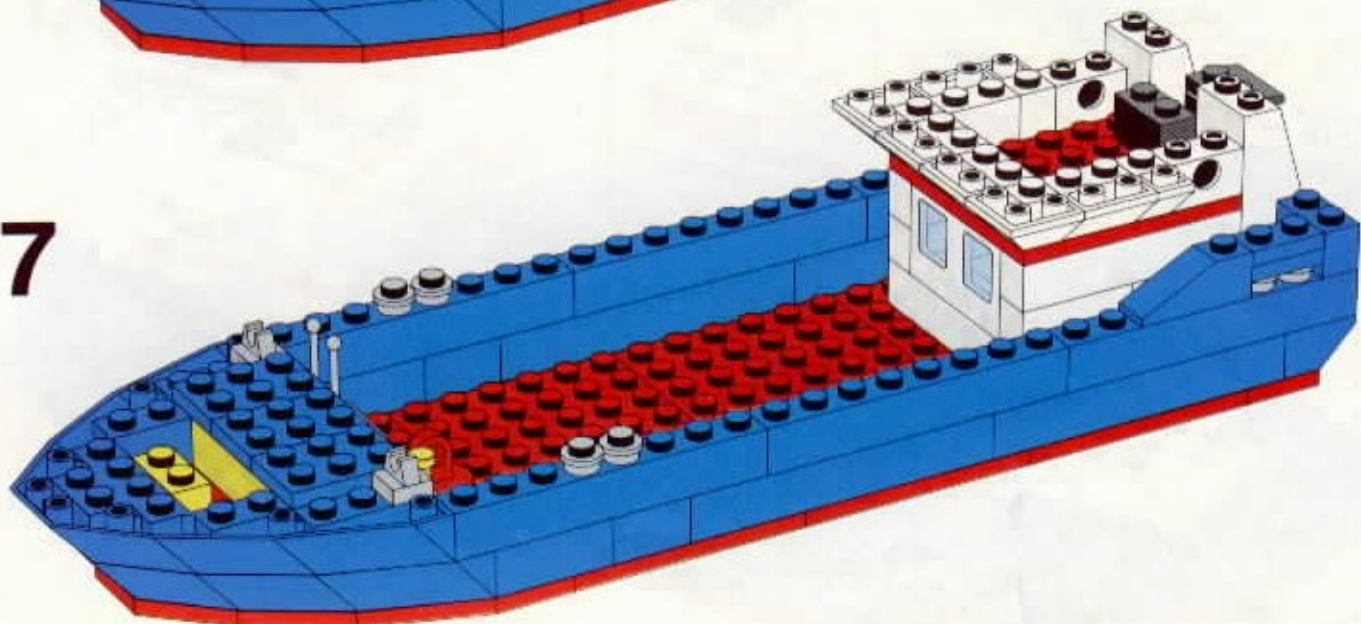



8

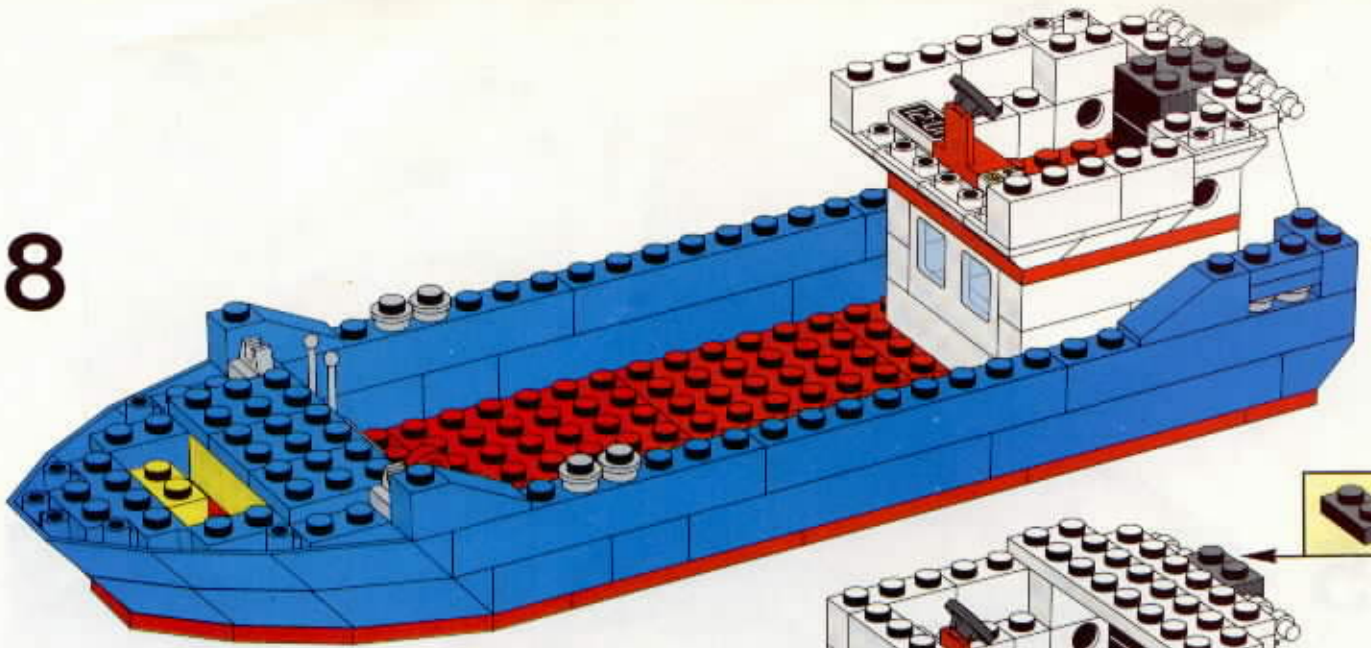

9

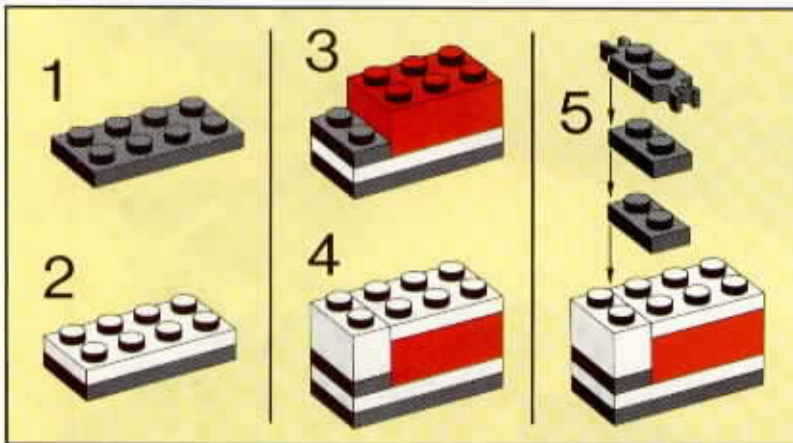
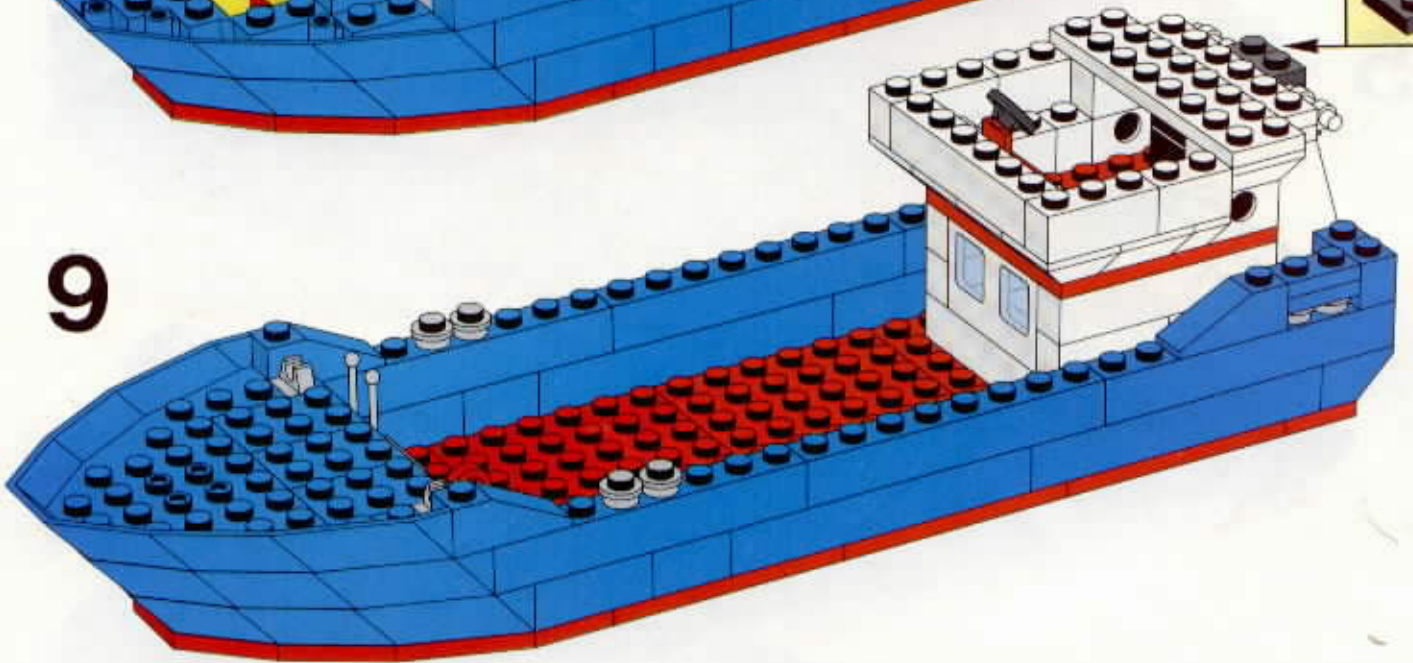

10

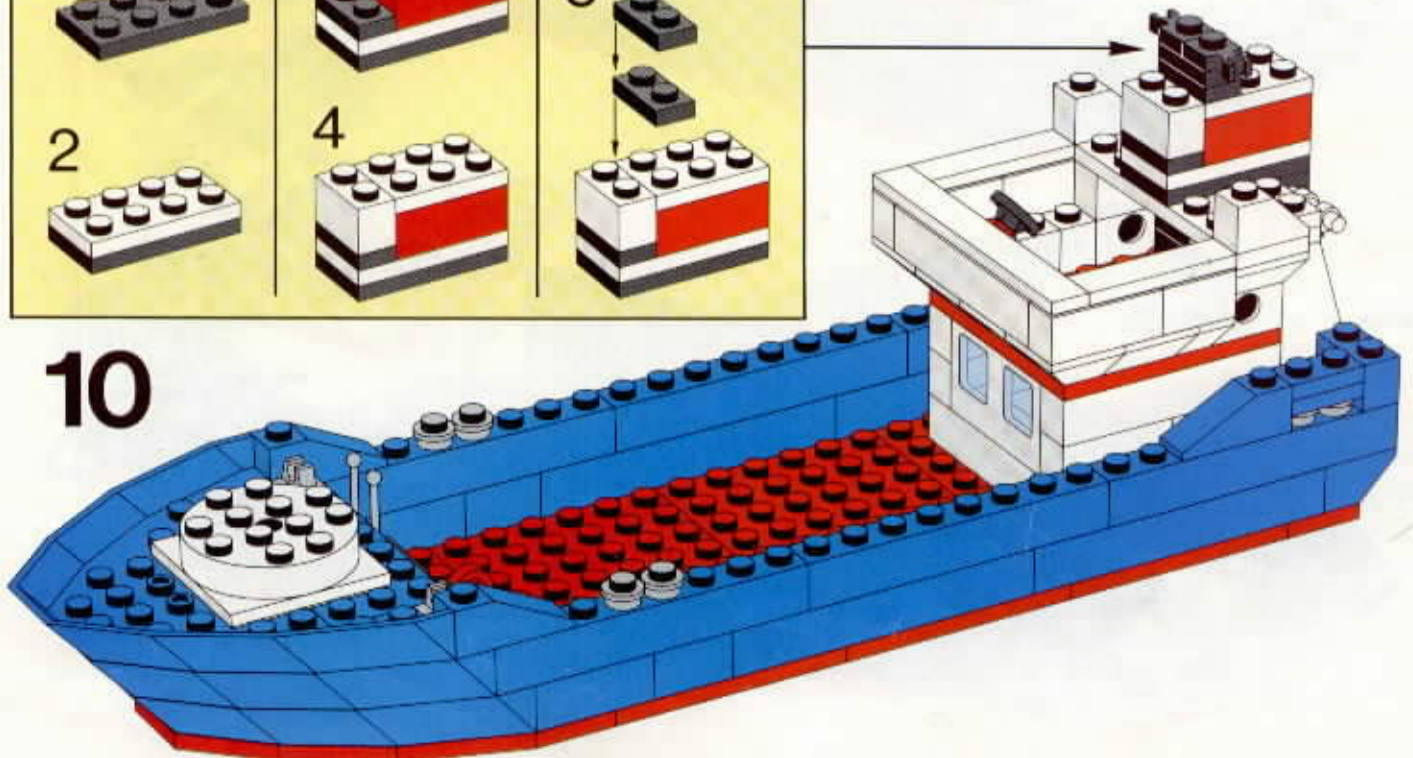



11

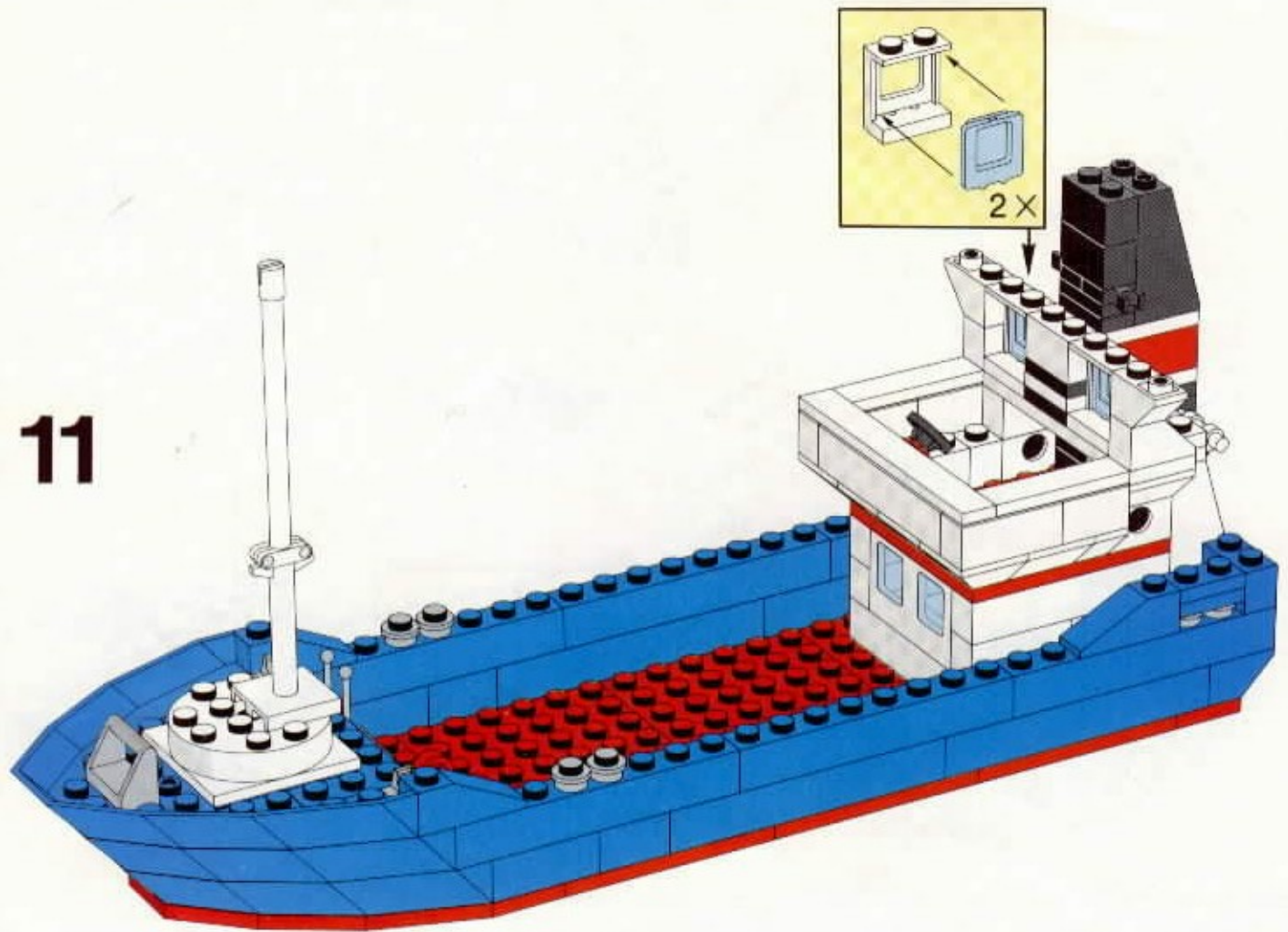

12

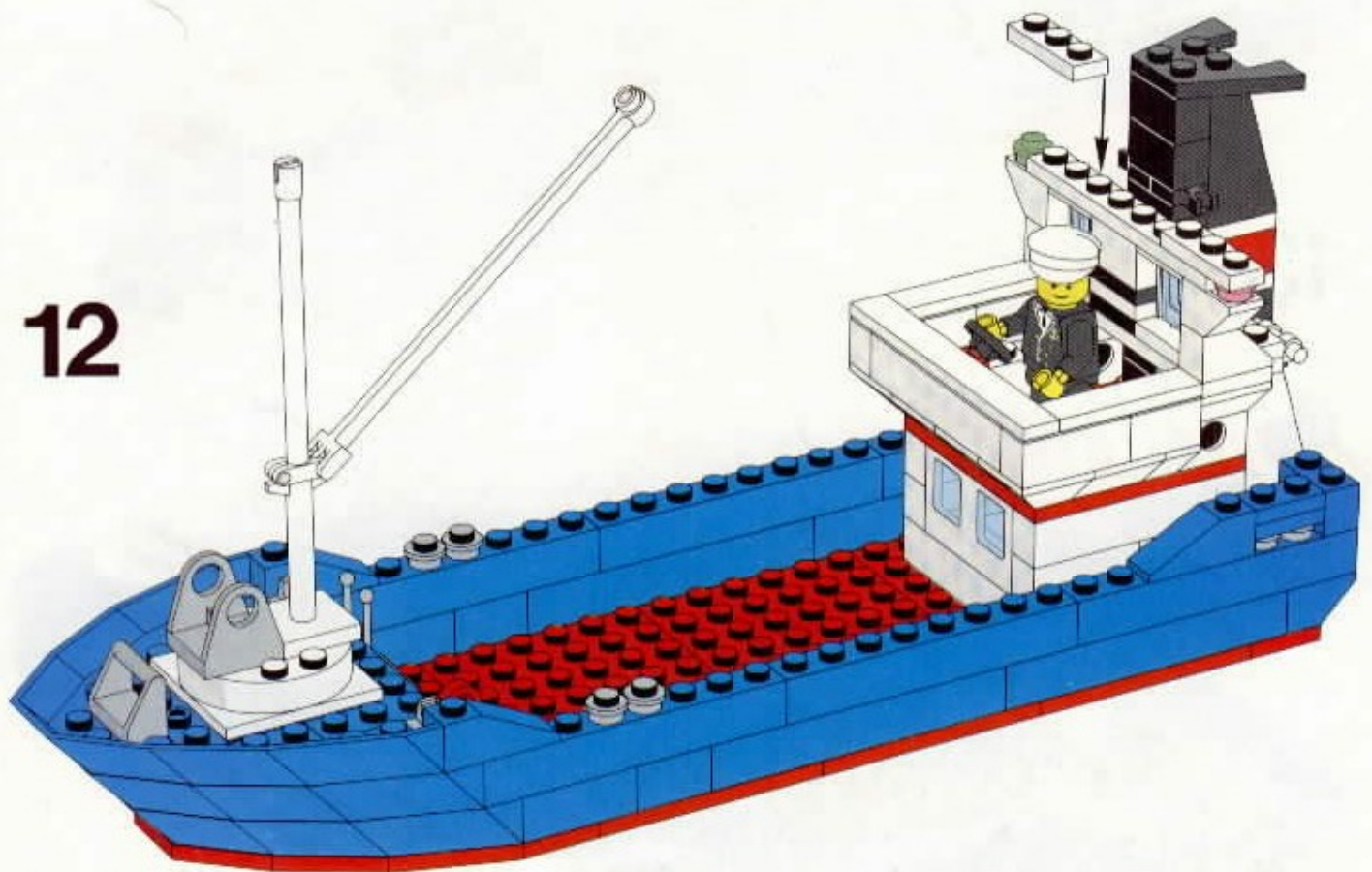



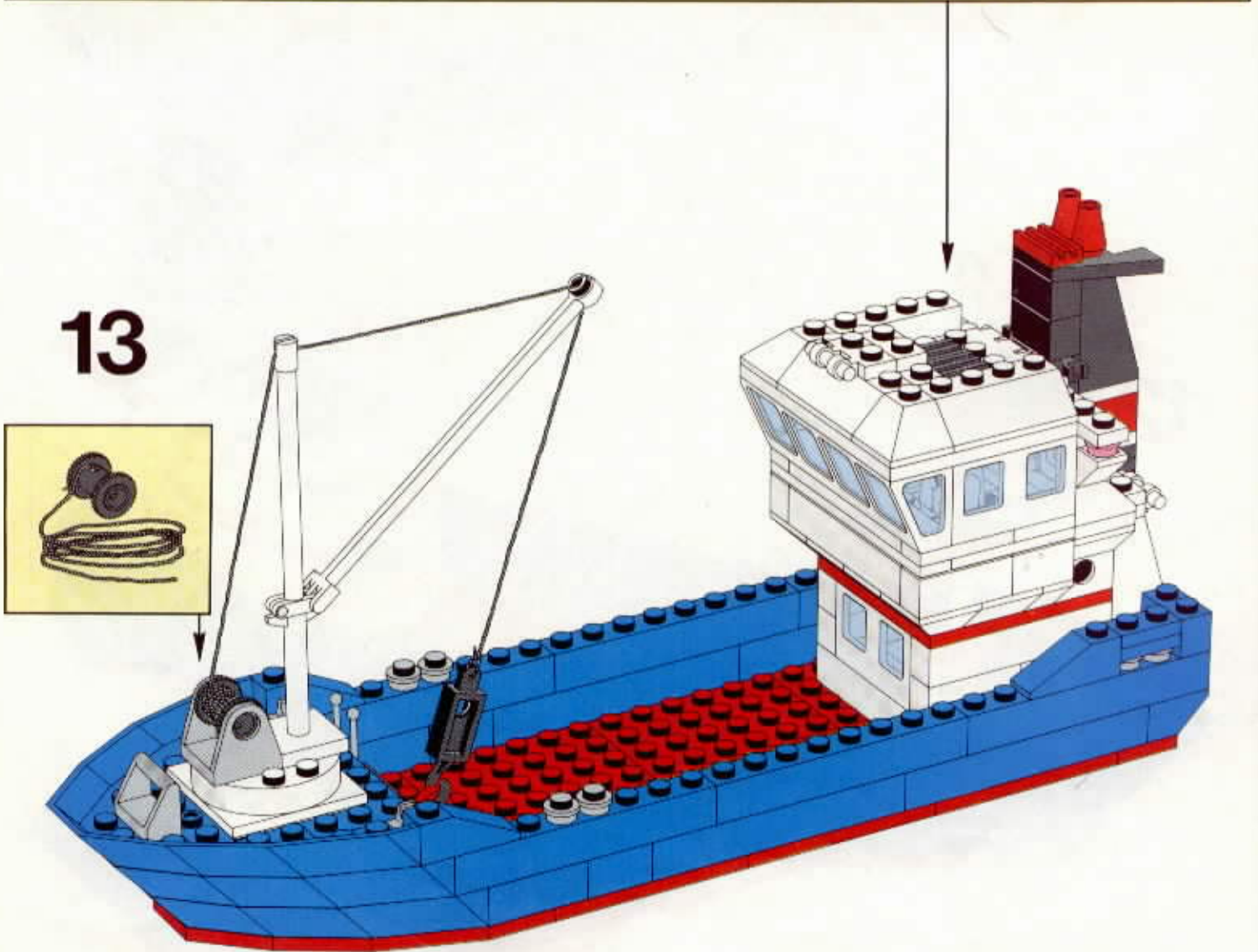
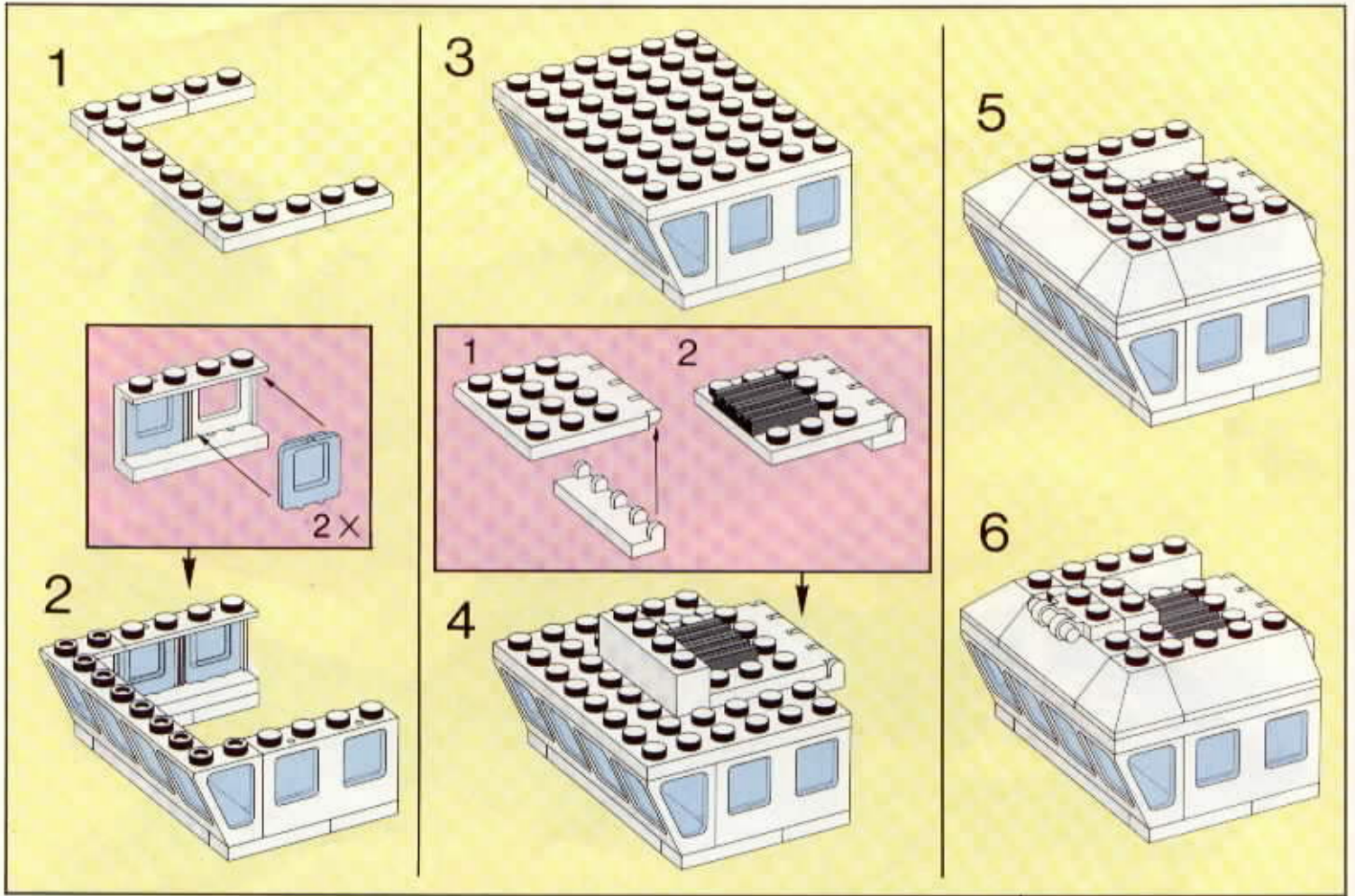



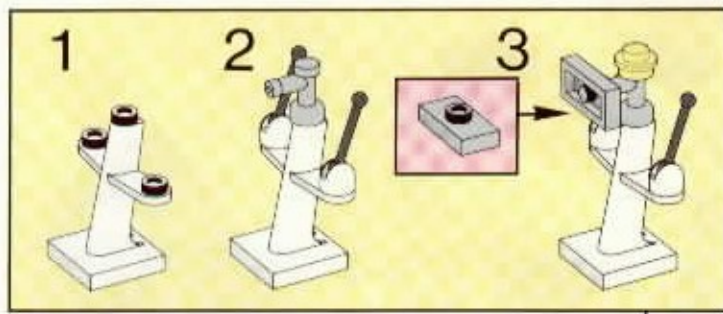

14

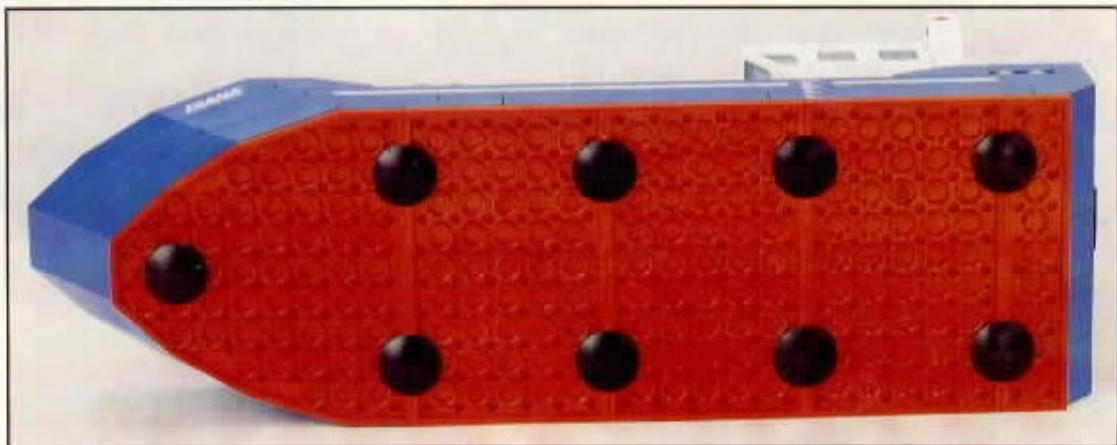
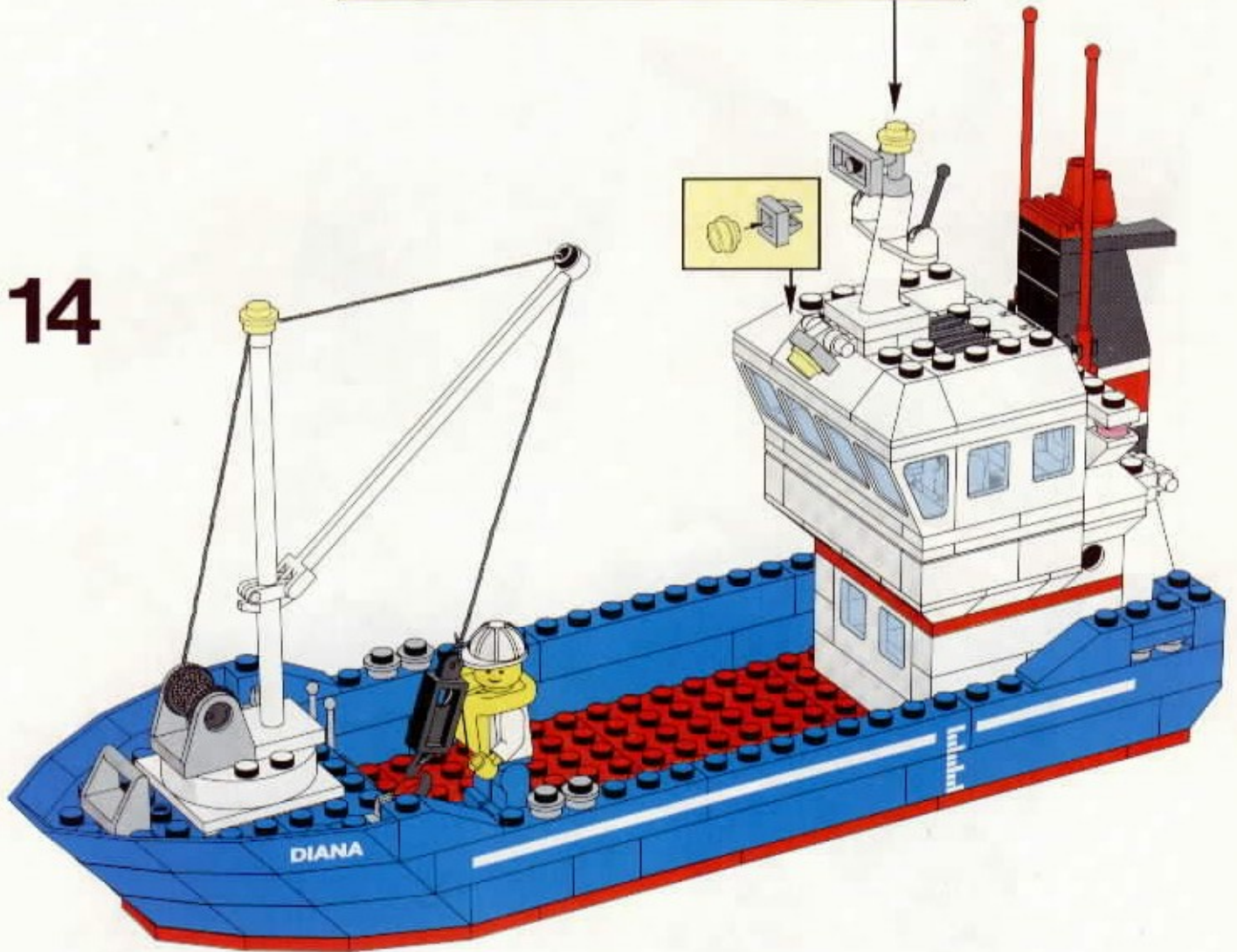



1

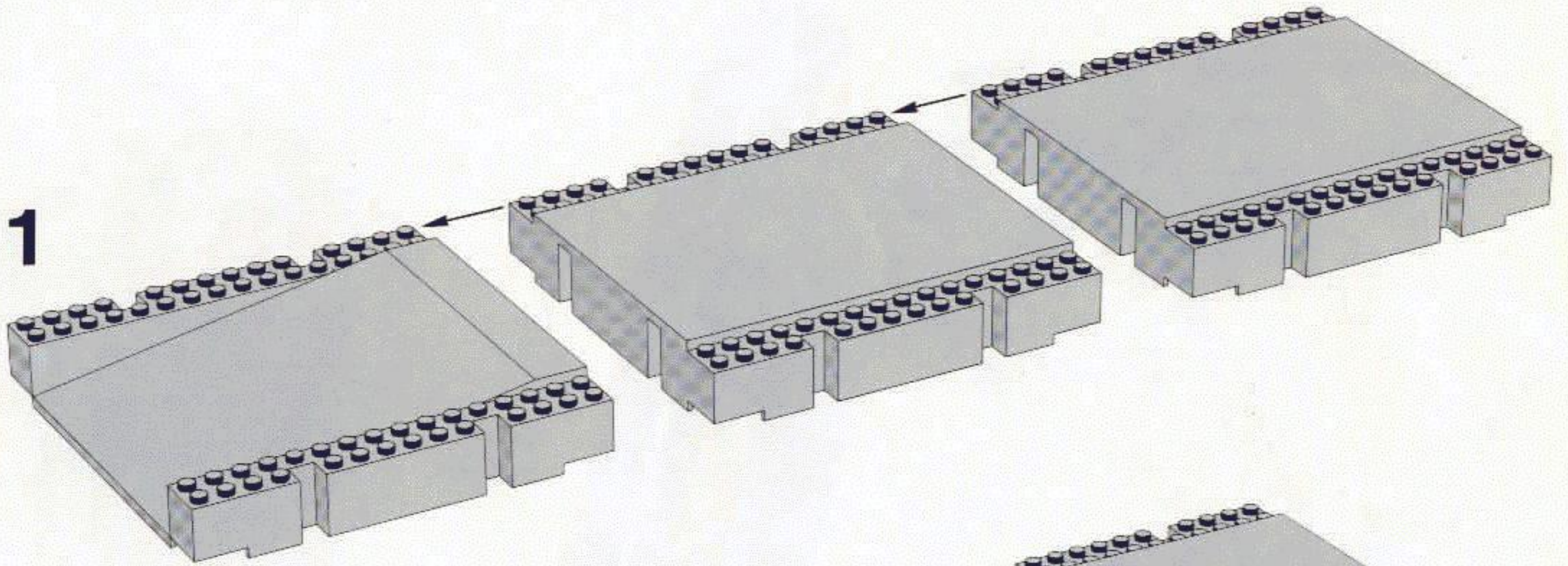

2

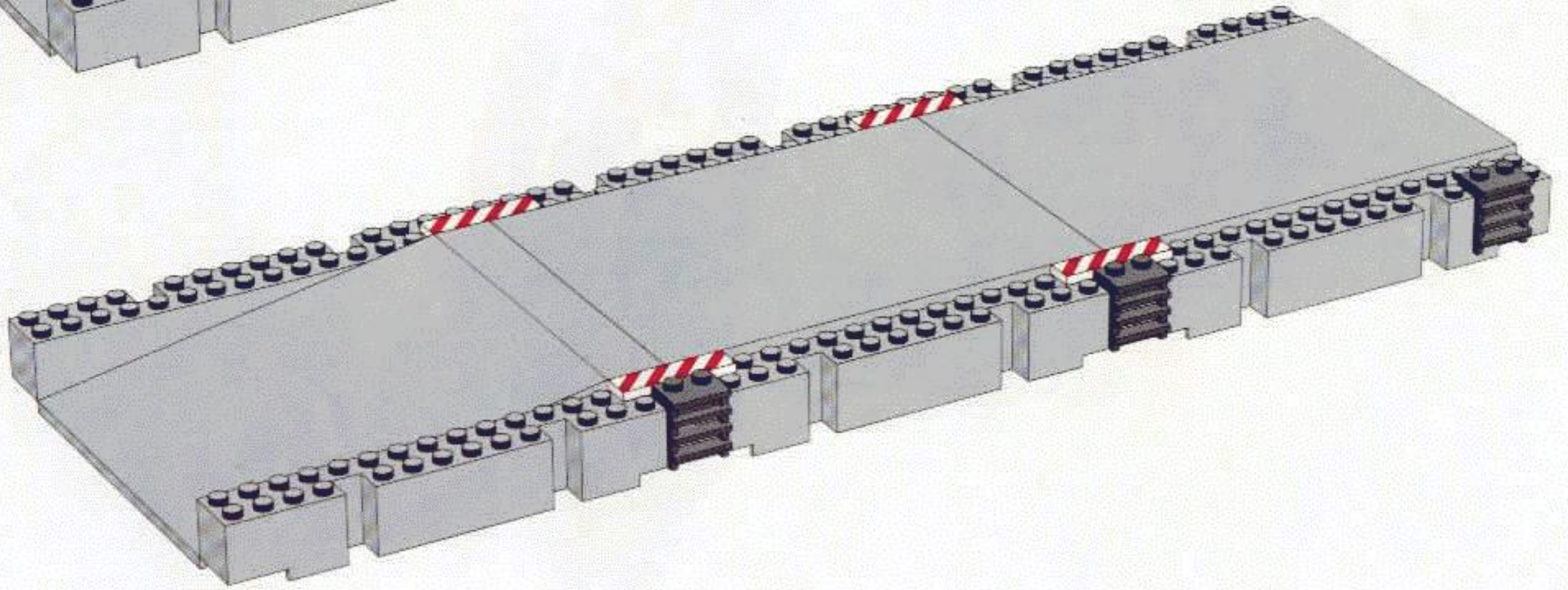



3

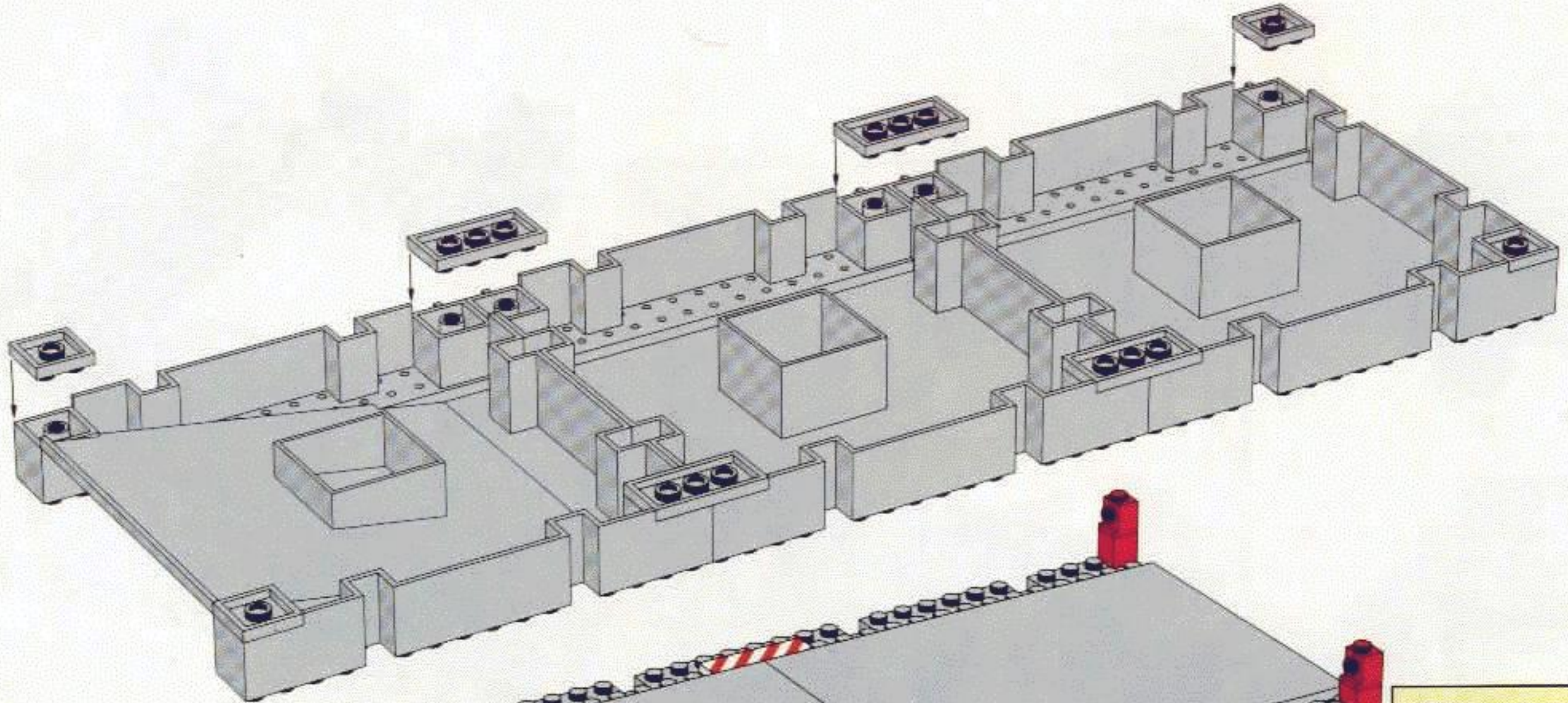

4

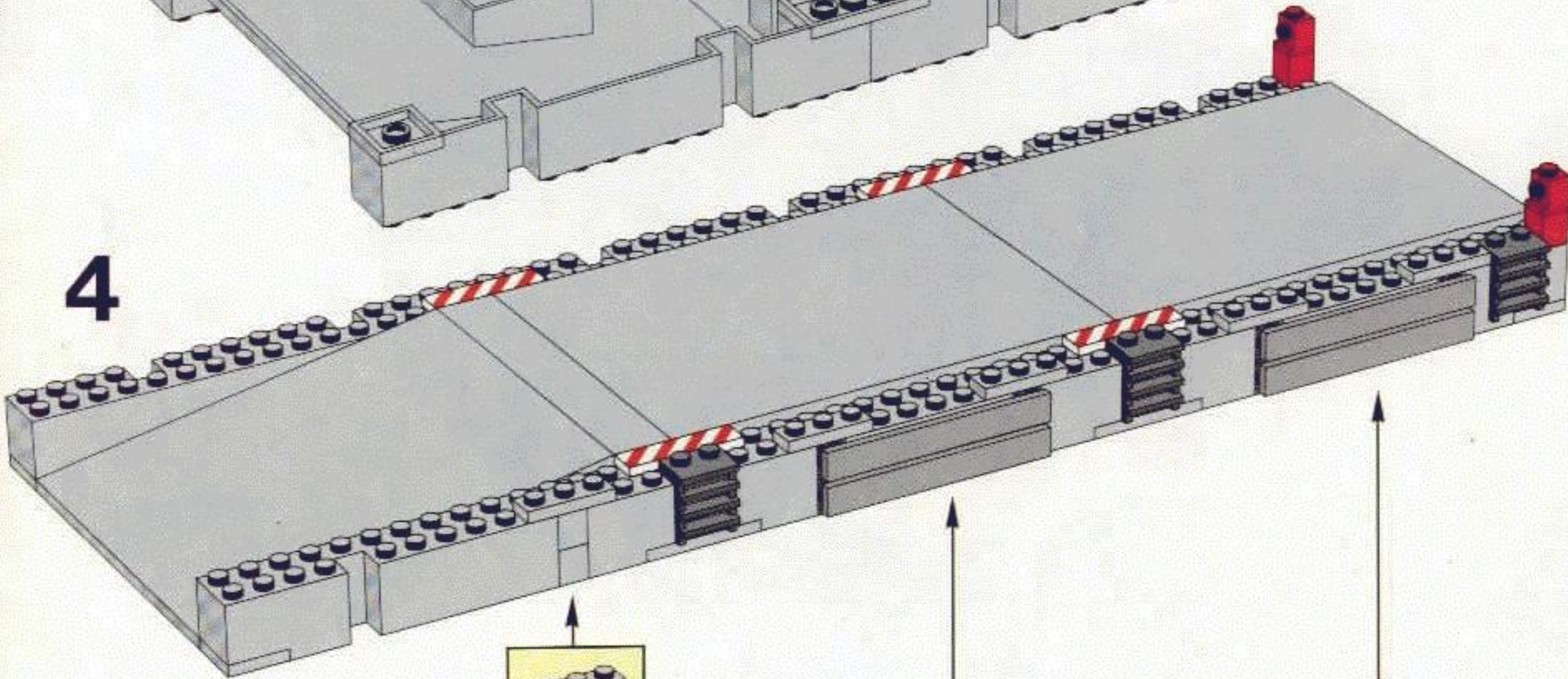

1		
2		
3		

2X



5

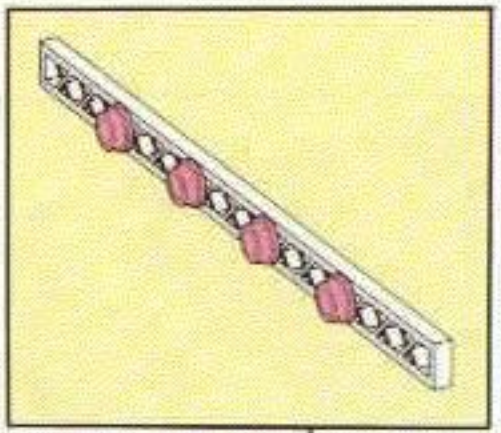
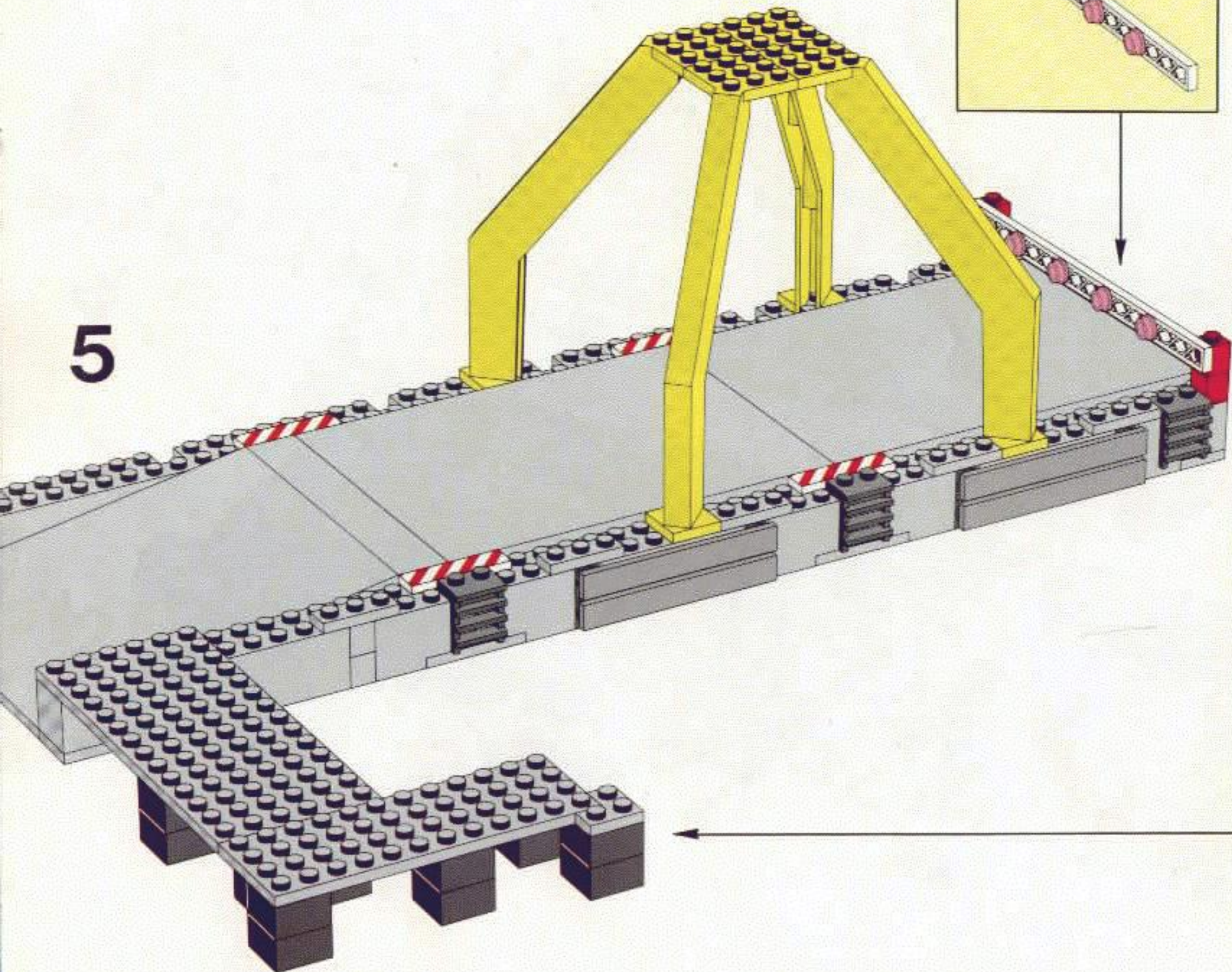

1

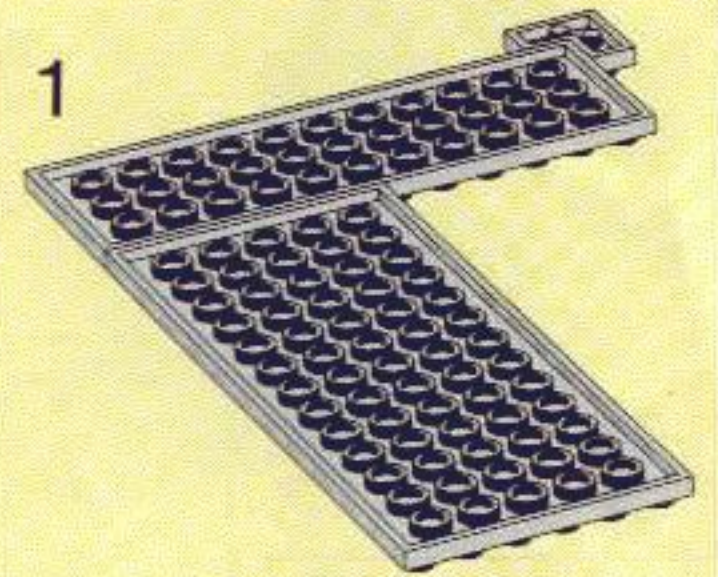

2

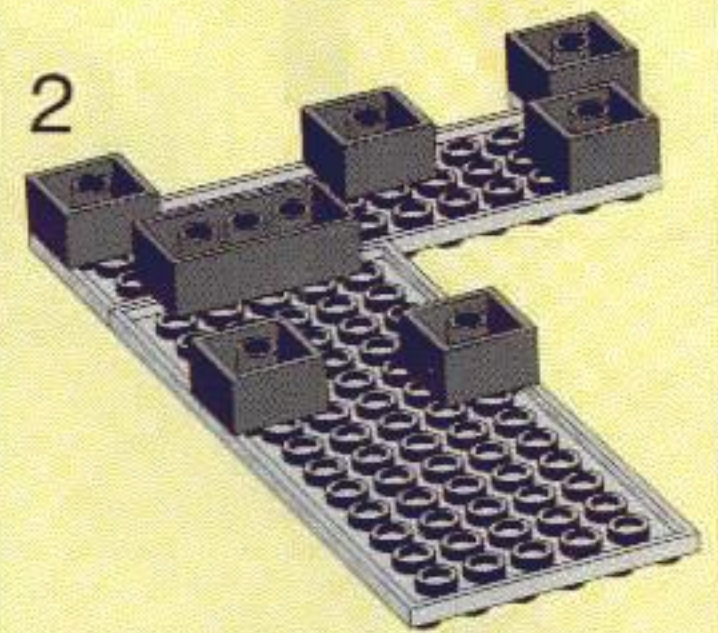



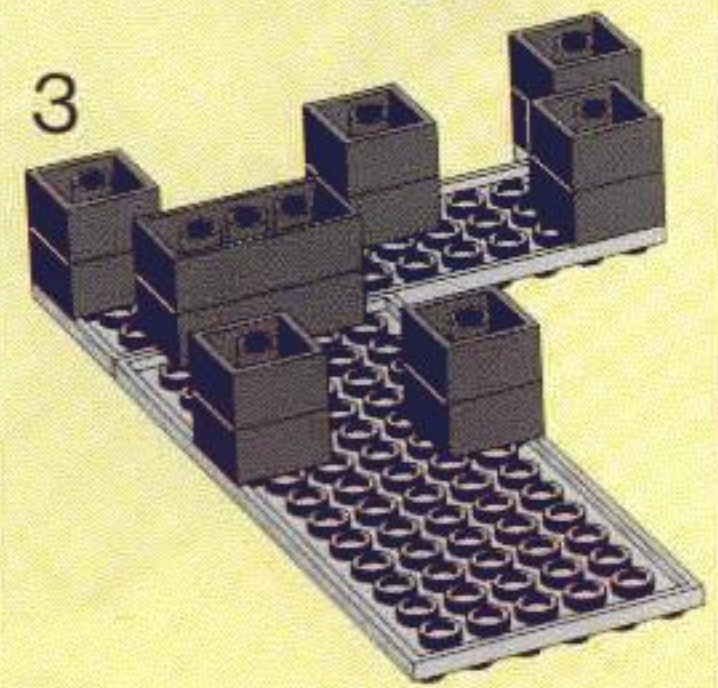

3





6

- 1 
- 2 
- 3 
- 4 

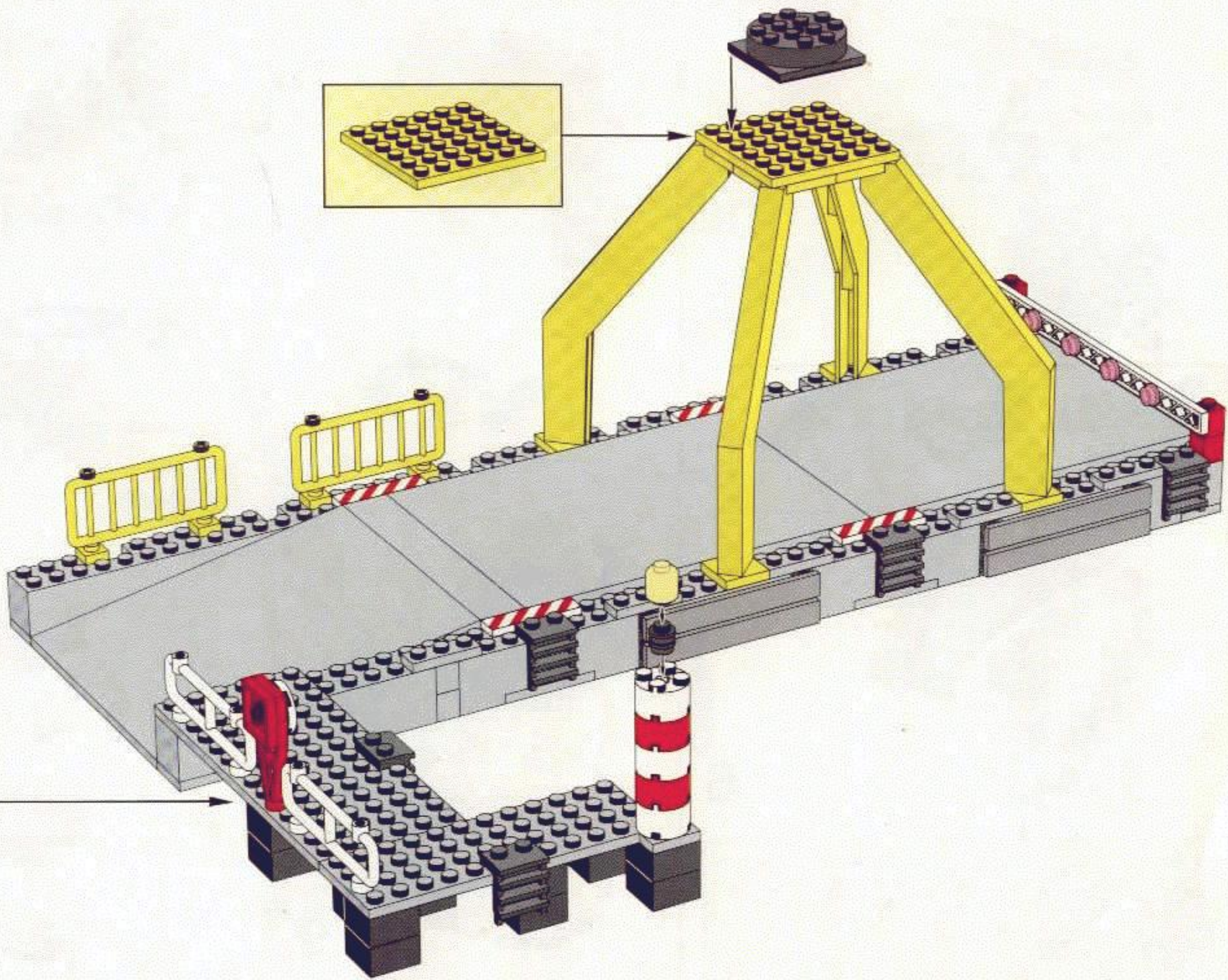



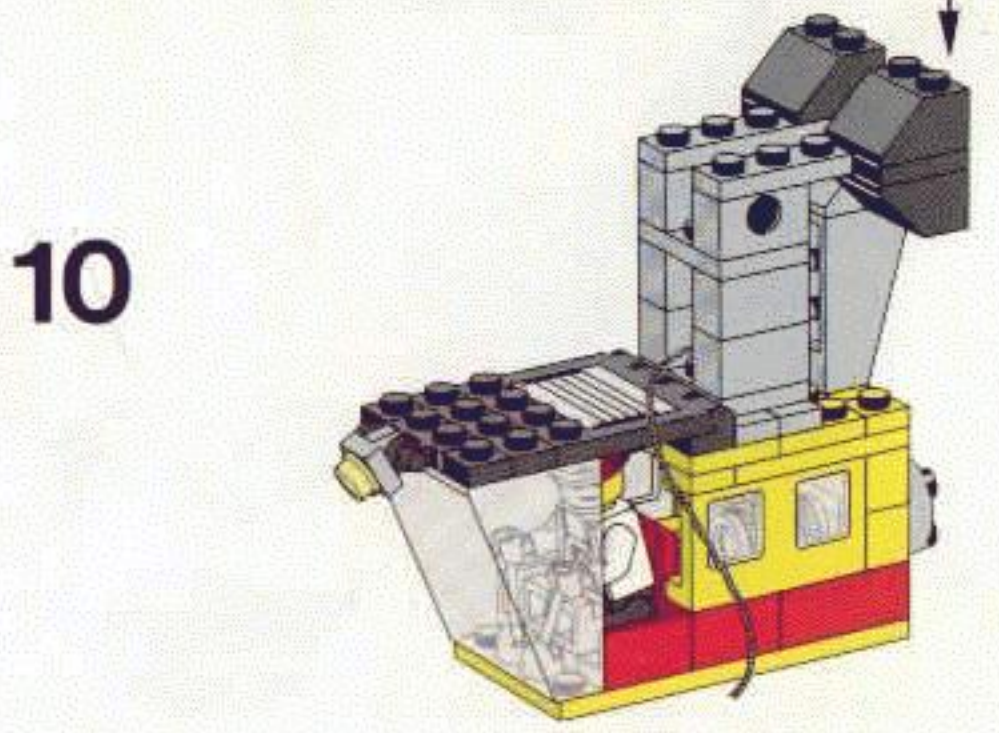
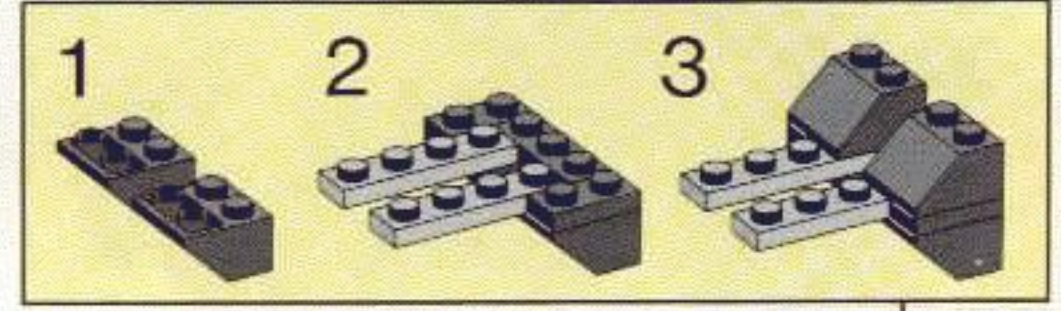
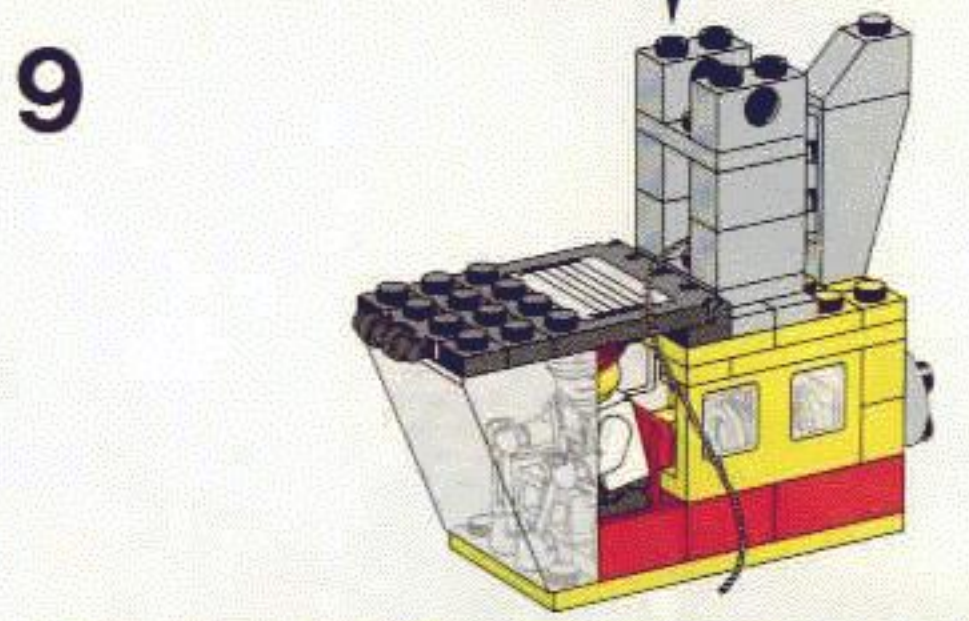
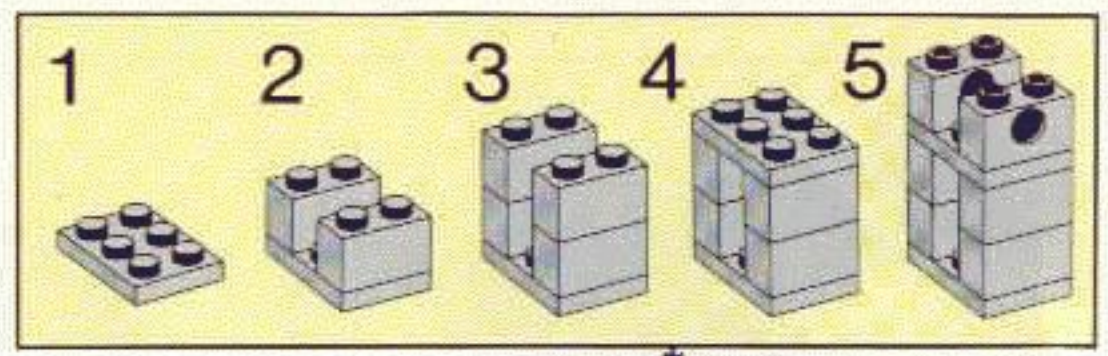
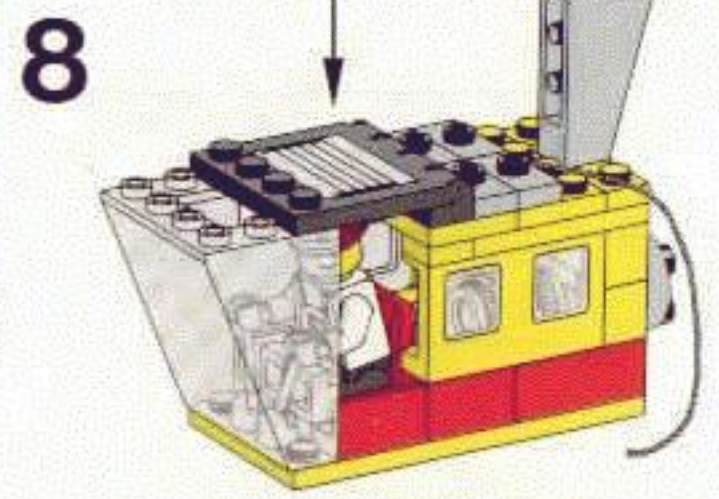
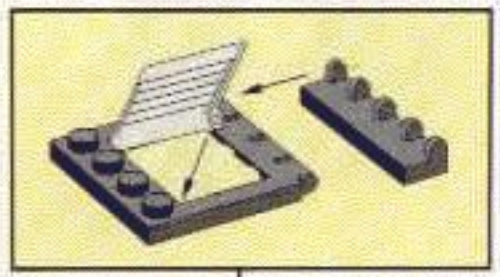
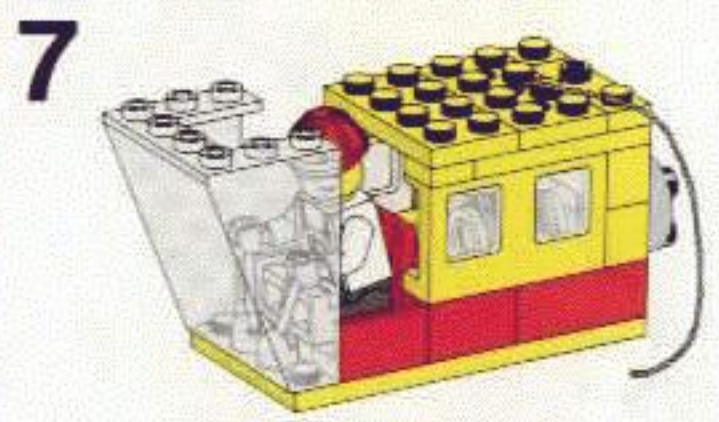
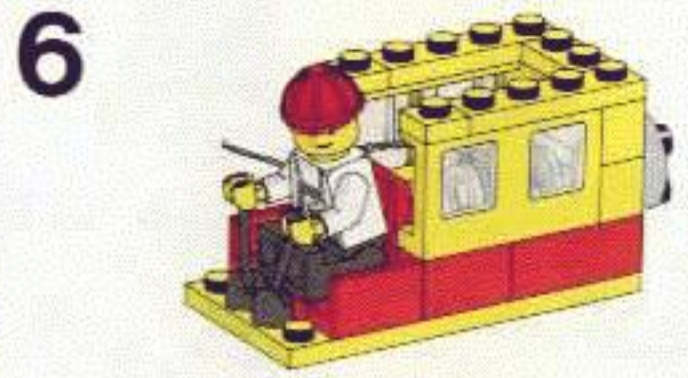
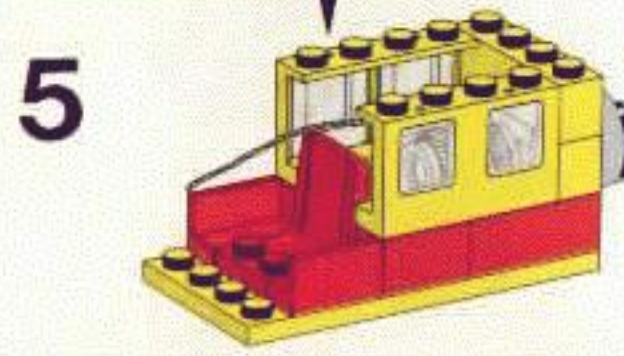
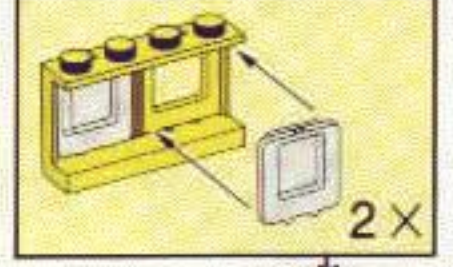
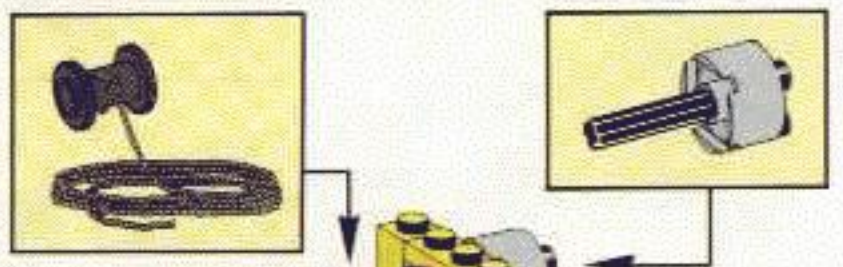
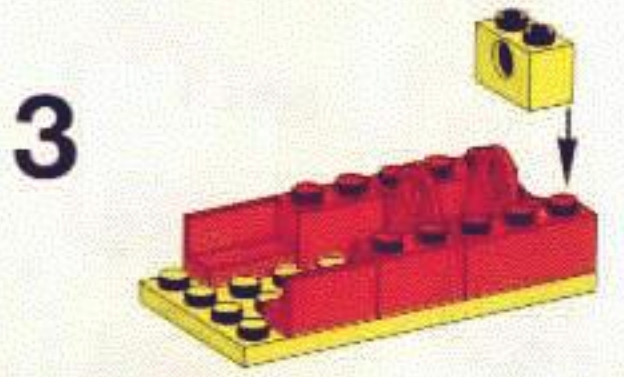
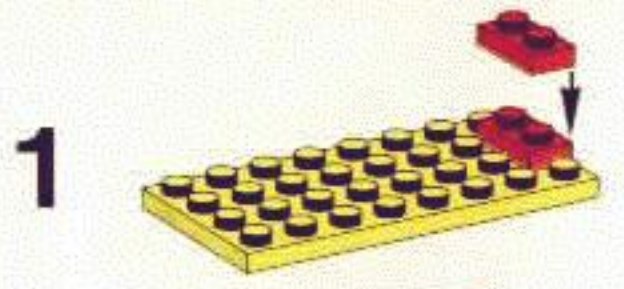



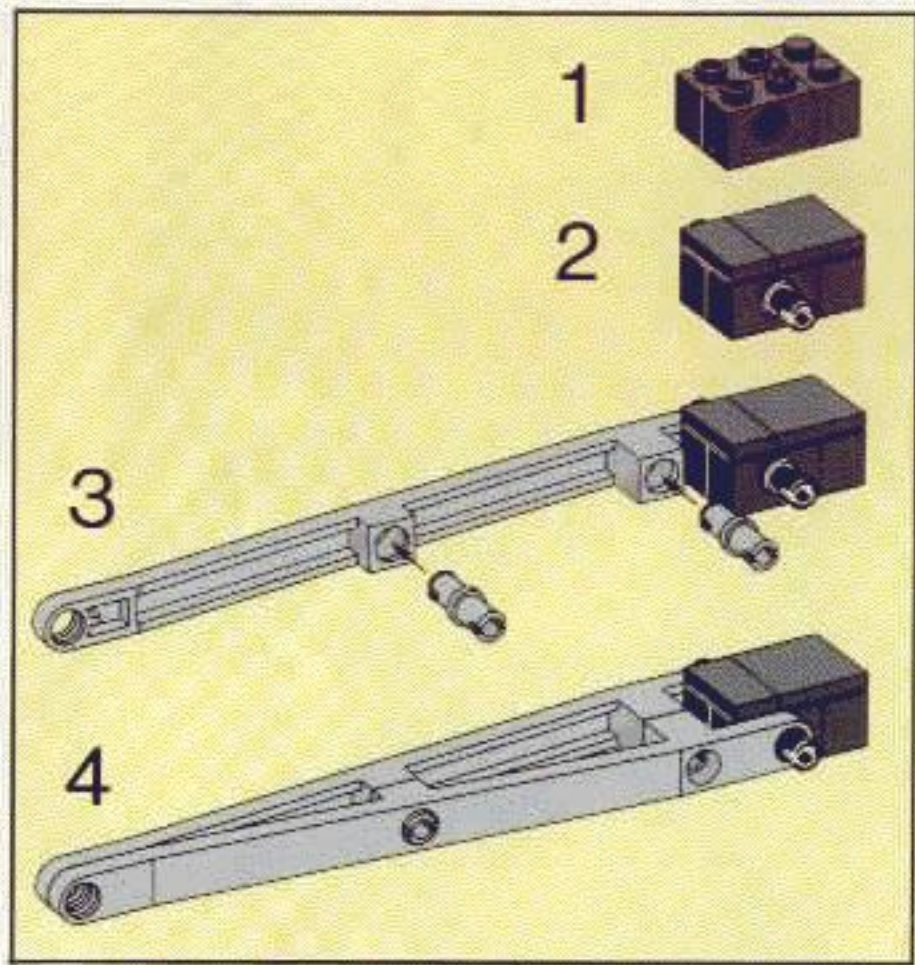

11

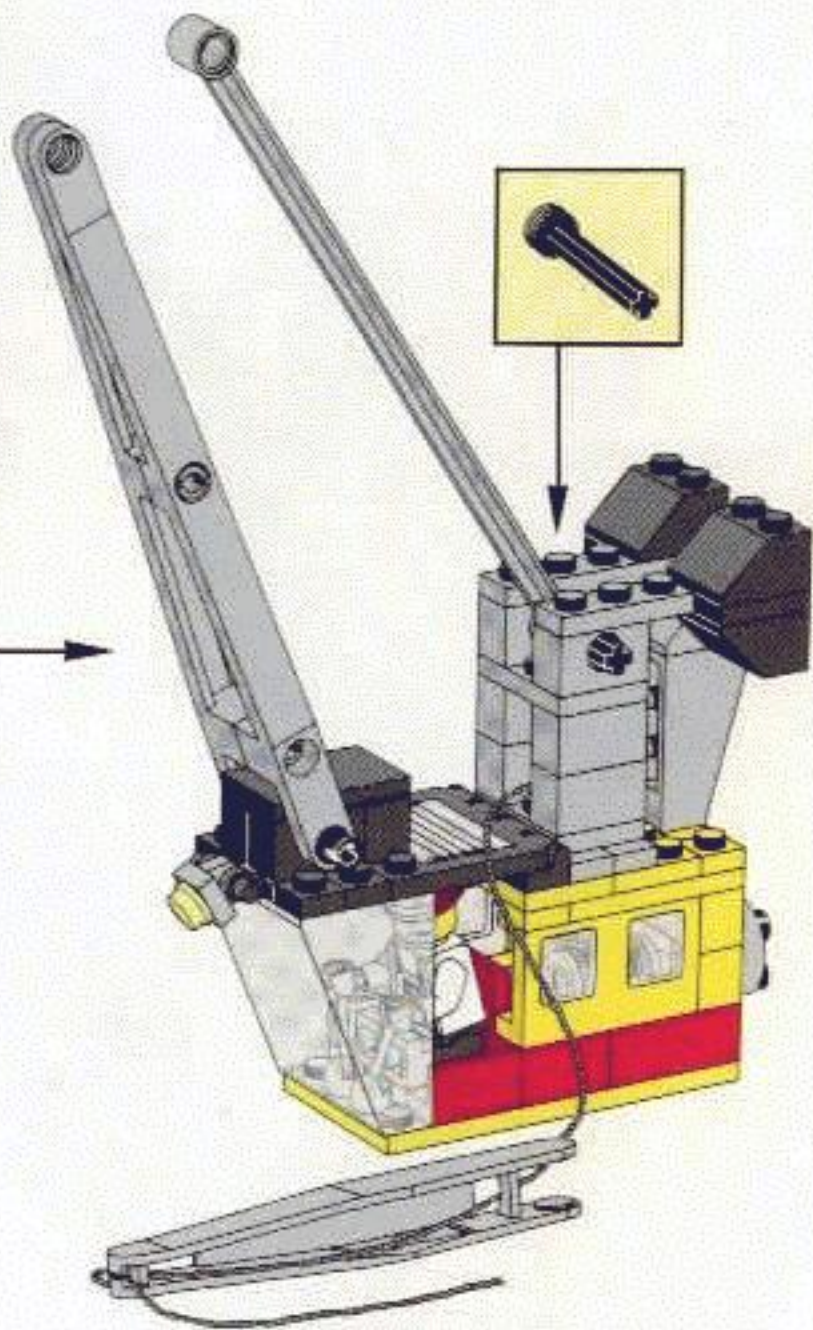

12

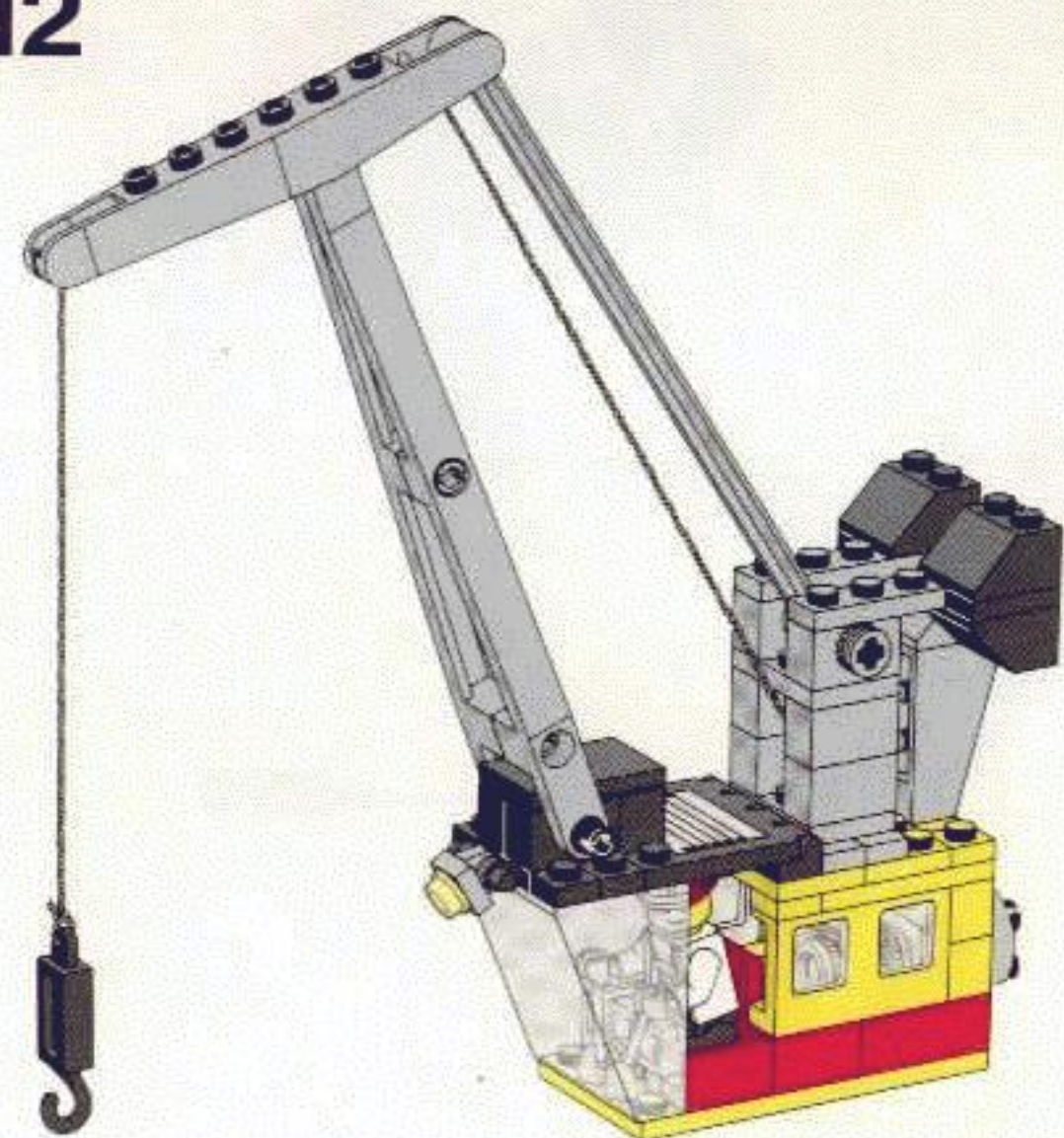



7

